

Product Code: CU2RCBO50C

Luckinslive 433886095

Description: Double Pole Bi-Directional True 6kA C Curve 50A 30mA RCBO

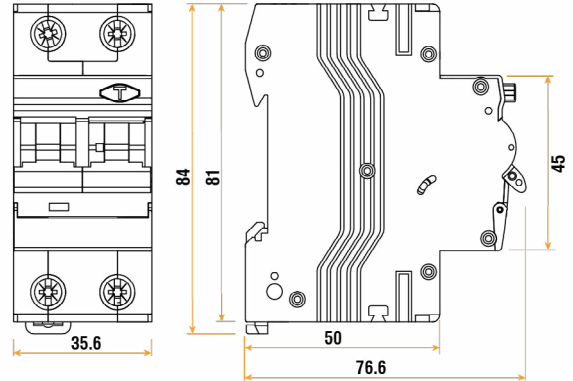

## General Information

Dimensions (mm)	35.6 (W) x 84 (H) x 76.6 (D)
Colour	Light Grey
Rated Operational Voltage (AC) (Ue)	230
Frequency (Hz)	50/60
Maximum Rated Current (A) (In)	50
Rated Breaking Capacity (True kA) (Ics)	6
Impulse Withstand Voltage (Uimp)	4000
Endurance Mechanical Operations	10000
Endurance Electrical Operations	4000
Type	A
Trip Curve	C
Rated Making & Breaking Capacity (A) (Im)	500
Tripping Current (mA) (in)	30
Residual Non-Operating Current (IΔn)	0.5
Trip Type	Ground Fault: Electronic Over Current: Thermal/Magnetic
Bi-directional	Yes
Device Terminals	Screwed Lug & Pin
Number Of Poles	2
Input Terminal Capacity - Flexible (mm <sup>2</sup> )	10
Input Terminal Capacity - Rigid (mm <sup>2</sup> )	16
Input Terminal Torque (Nm)	2
Output Terminal Capacity - Flexible (mm <sup>2</sup> )	10
Output Terminal Capacity - Rigid (mm <sup>2</sup> )	16
Output Terminal Torque (Nm)	2
Circuit Protection	Earth fault, overcurrent & short-circuit
Ingress Protection	IP20
Operational Temperature (°C)	-25 to +40
Warranty (Years)	3
<b>Standards</b>	BS EN 61009-1

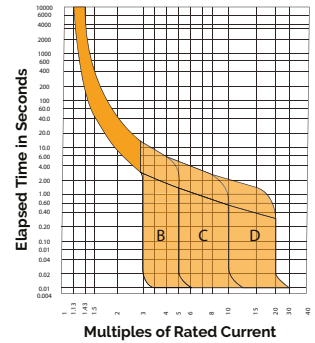

## Additional Information

For cleaning / polishing of products, use only a soft, dry, clean cloth.  
The RCBOs within our consumer units are designed to withstand insulation resistance tests at 500V.